

# CL Challenger Lifts



**Model#: 15002**  
Heavy-Duty 2-Post Lift  
15,000 lb. capacity





## Heavy-Duty 2-Post Lifts

Whether you want to expand your fleet service capabilities, avoid downtime or just increase your bottom line, Challenger Lifts' 12,000, 15,000 and 18,000 lb. 2-post lifts are the solutions for your servicing needs. Not only does our Heavy-Duty Series lift a lot, it's a lot of lift. With features that you would expect to pay more for, like low profile arms, padded overhead cut-off bar, adapter accessories, etc. In fact, no other lift company gives you more.

Model Number	12000	12001	12002	15000	15002	18000	18002
Lifting Capacity	12,000 lb. (5443kg)	12,000 lb. (5443kg)	12,000 lb. (5443kg)	15,000 lb. (6804kg)	15,000 lb. (6804kg)	18,000 lb. (8165kg)	18,000 lb. (8165kg)
<b>A</b> Rise Height <sup>1</sup>	85 <sup>1</sup> / <sub>4</sub> " (2153mm)			85 <sup>1</sup> / <sub>2</sub> " (2172mm)		85 <sup>1</sup> / <sub>2</sub> " (2172mm)	
<b>B</b> Height Overall	13' 8" (4166mm)	14' 8" (4470mm)	15' 8" (4775mm)	14' 6" (4420mm)	16' 6" (5029mm)	14' 6" (4420mm)	16' 6" (5029mm)
<b>C</b> Width Overall	11' 10" (3607mm)			12' 10 <sup>3</sup> / <sub>4</sub> " (3931mm)		12' 10 <sup>3</sup> / <sub>4</sub> " (3931mm)	
<b>D</b> Drive-Thru Clearance	104 <sup>1</sup> / <sub>2</sub> " (2654mm)			104 <sup>1</sup> / <sub>4</sub> " (2711mm)		104 <sup>1</sup> / <sub>4</sub> " (2711mm)	
<b>E</b> Floor-Overhead Switch	157" (3988mm)	169" (4293mm)	181" (4597mm)	167" (4242mm)	191" (4851mm)	167" (4242mm)	191" (4851mm)
<b>F</b> Arm Reach (Min.)	37" (940mm)			38 <sup>1</sup> / <sub>2</sub> " (978mm)		38 <sup>1</sup> / <sub>2</sub> " (978mm)	
<b>G</b> Arm Reach (Max.)	54" (1372mm)			62" (1575mm)		62" (1575mm)	
<b>H</b> Adj. Adapter Height <sup>2</sup>	5 <sup>1</sup> / <sub>4</sub> " - 7 <sup>1</sup> / <sub>4</sub> " (127- 171mm)			6 <sup>5</sup> / <sub>8</sub> " - 8 <sup>1</sup> / <sub>2</sub> " (159 - 216mm)			
<b>I</b> Adj. Adapter Height <sup>2</sup> (with Medium Extensions)	8 <sup>1</sup> / <sub>4</sub> " - 10 <sup>1</sup> / <sub>4</sub> " (203 - 248mm)			10 <sup>5</sup> / <sub>8</sub> " - 12 <sup>1</sup> / <sub>2</sub> " (260 - 318mm)			
<b>J</b> Adj. Adapter Height <sup>2</sup> (with High Extensions)	11 <sup>1</sup> / <sub>4</sub> " - 13 <sup>1</sup> / <sub>4</sub> " (279 - 324mm)			14 <sup>5</sup> / <sub>8</sub> " - 16 <sup>1</sup> / <sub>2</sub> " (362 - 419mm)			
<b>K</b> Inside Columns	114 <sup>1</sup> / <sub>2</sub> " (2908mm)			119 <sup>7</sup> / <sub>8</sub> " (3048mm)		119 <sup>7</sup> / <sub>8</sub> " (3048mm)	
Air Supply Required	85-115 psi			85-115 psi		85-115 psi	
Motor	2HP			2HP		3HP	
Voltage (1Phase Std.) <sup>3</sup>	208v-230v			208v-230v		208v-230v	
Speed of Rise	60 Sec.			60 Sec.		60 Sec.	
Ceiling Height Required	13' 9" (4191mm)	14' 9" (4496mm)	15' 9" (4801mm)	14' 8" (4470mm)	16' 8" (5080mm)	14' 8" (4470mm)	16' 8" (5080mm)

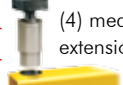
<sup>1</sup> Rise height is measured with high extension. <sup>2</sup> Medium and high auxiliary adapter extensions are standard. <sup>3</sup> Optional 3 phase electrical also available, please specify at time of order. † Frame engaging adapters are REQUIRED when lifting vehicles with frame construction. Standard lift colors are Red and Blue.

**standard features:**

-  (4) standard adapters
-  (4) medium extensions
-  (2) high extensions
-  (4) frame engaging adapters  
† Part#: 10318
-  (4) reducer bushings for use with frame engaging adapters  
Part#: 10317  
(Lift Models 15000 & 18000 only)
-  (2) organizer racks for adapter extensions  
(2) Part#: 10316

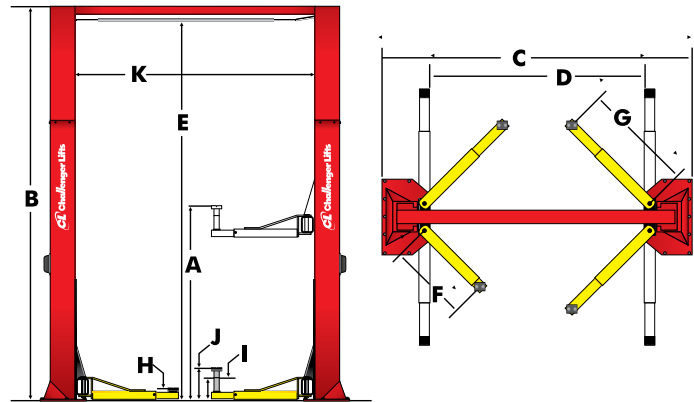

For more information, contact your Authorized Challenger Lifts Distributor:



The Automotive Lift Institute (ALI) certifies the Heavy-Duty 2-Post Lifts (12000, 15000, and 18000 Series) described herein comply with the applicable provisions of the American National Standards ANSI/ALI ALCV 2011 and are Third Party Validated by the ETL Testing Laboratory.

**CHALLENGER LIFTS, INC.**  
200 Cabel Street  
Louisville, Kentucky 40206

Phone Toll-Free: 800-648-5438  
502-625-0700  
502-625-0711  
E-mail: sales@challengerslifts.com

Challenger Lifts, Inc. reserves the right to make changes to specifications without notice and without making changes retroactive. Unloading, installation and oil not included.