

NT010A

Two Post One Side Handle Release Hydraulic Lift

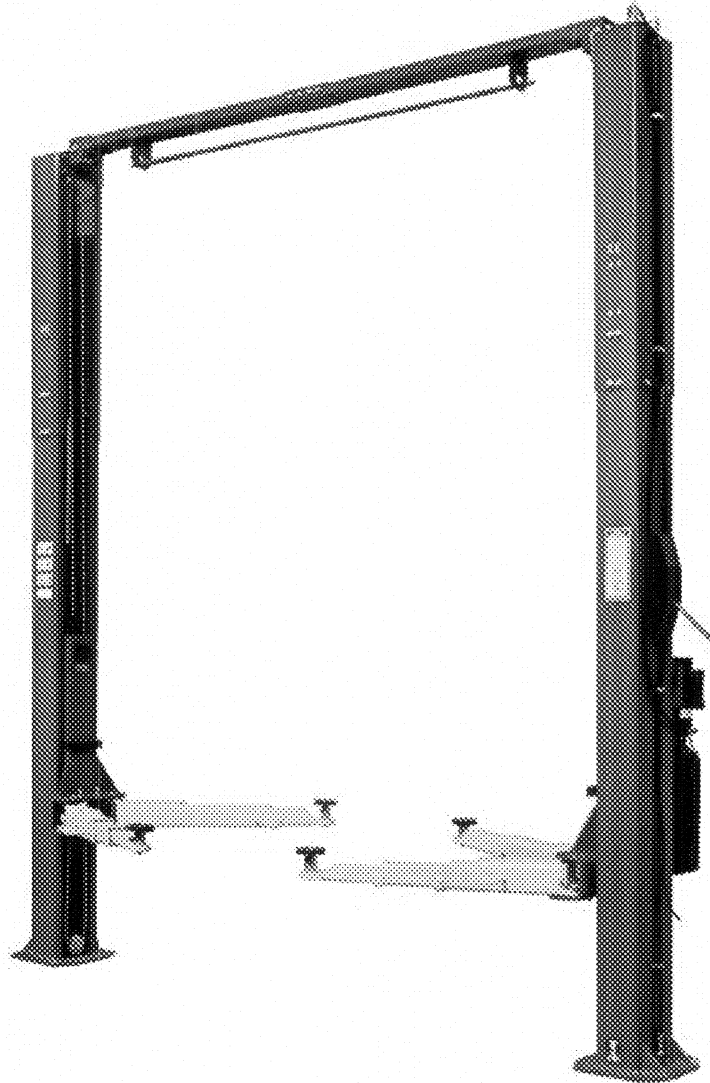



Special Instruction

- The buyer should claim the compensation from the carrier if any damage happens to the equipment during shipping.
- Though we have taken the safety into consideration during designation and produce, some training is quite necessary. Without reading this manual, please don't operate and maintain the lift.
- Read the requirement for power source and electric current on the nameplate of motor, and make sure that the wire should be connected by specialized electrician.
- Our company is not responsible for giving notice of any further change on partial structure of the lift after selling the lift.
- Any vehicle whose weight is above 10000 lbs is not allowed to be raised on this machine.

Read the warning signal on the equipment carefully.

Contents

1. Security Instruction and Attentions.....	4
1.1 Text Tip Signal.....	4
1.2 Safety Warning Signal.....	4
1.3 Using Purpose.....	7
1.4 The Expected Rated Load Assign.....	7
1.5 Safety Notice Points.....	8
2. The Simple Introduction of main parts of the Equipment.....	8
3. Basic Parameters of Equipment.....	9
5. Checking points before Using.....	17
5.1 General Checking Points.....	17
5.2 Key Checking Points.....	18
6. Operation Instruction.....	18
7. Maintenance and Care of the Equipment.....	20
7.1 Day Care.....	20
7.2 Month Care.....	21
8. Trouble Shooting.....	22

1. Security Information and Notice Points

1.1 Text Tips Signal

In this instruction manual, contents about safety should be paid special attention. Here are some signals with the explanation on the right hand.



If there is this signal before any passage, it means that operation like this is wrong and will lead to big casualty or heavy damage to the device.



The figure appearing before passage shows that it is not allowed to operate according to the passage, or the potential risk will develop into big casualty and heavy damage to the lift.



The passage besides this signal lists the notice points and security requirements during the process of normally using, maintenance and care of the lift.

1.2 Safety Warning Signals

Please read Safety Signage carefully, understand and remember them.

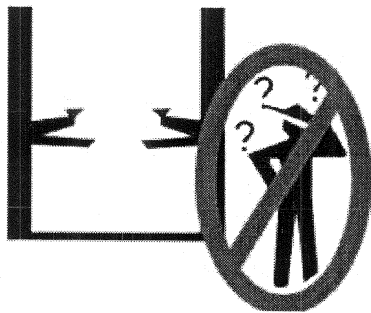

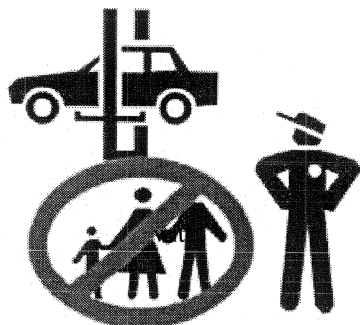

Only trained person can operate and use the lift.



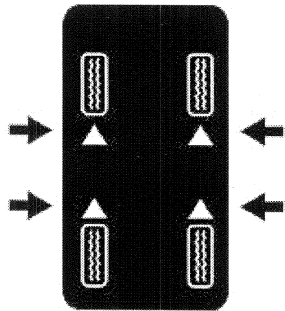

Never let non-trained personnel come in contact

Lift.

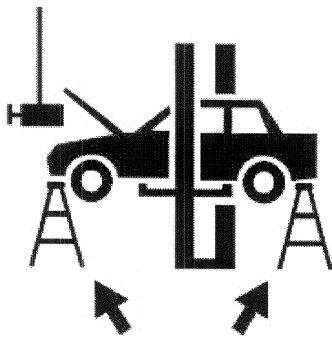

 It's suggested by the manufacturer that the raising position should be the points of support.



 When install and move some big or heavy parts on the car during the maintenance, bracket should be used to keep the car's balance.

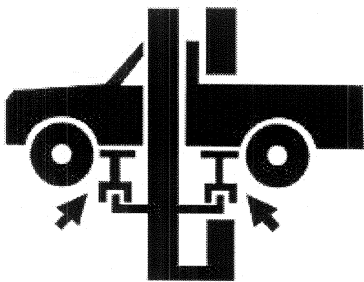

 Using the high bracket if necessary.

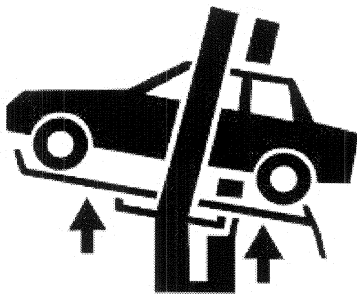

 Supplementary bracket will reduce the heavy burden of the car on the lift when rise.

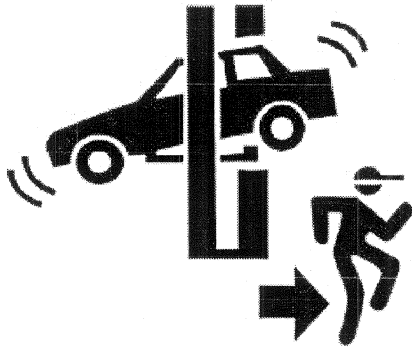

 Clear area if vehicle is on danger of falling.



 Center of gravity of the car should be at center of arms' acting force.

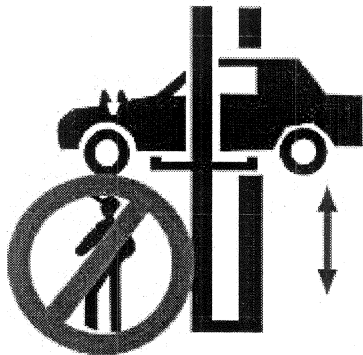

 Keep away from the working area when raise or drop vehicles.

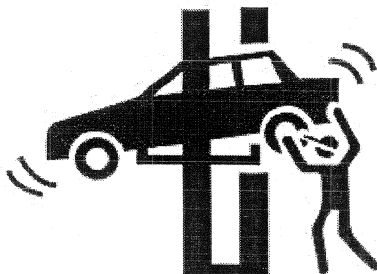

 Forbid to rock the car during lift's rising

and lowering.



Don't modify any controlling parts or mechanical parts of the lift privately.

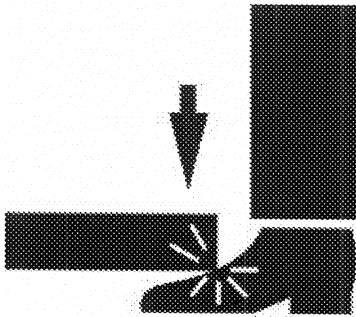

Keep feet clear of lifting when lowering. Avoid pinch points.

1.3 Using Purpose

The lift is used to lift vehicles whose weight is less than 9000lbs. Other usages are not allowed.

1.4 Expected Rated Load Distribution

	Rated Load	Load Distribution	
		Former part : Latter part	Minimum Maximum
NT010A	10000 lbs	2:3	3:2

In principle, the lift we design supports double direction placement of the car, however, it's better to use the short arm to support the motor end, because in this case there will be less wear and tear for the lift.

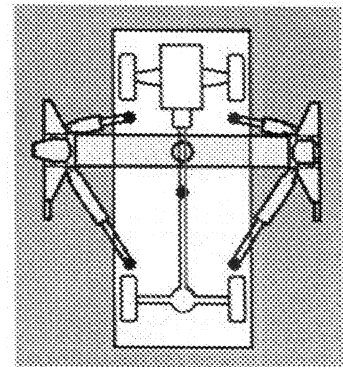

1.5 Safety Notice Points

- . Operators should read the manual carefully to avoid accidents.
- . Operators should be familiar with all functions and operating methods of the lift.
- . Check before operating and regular check must be carried out too.
- . If there is any abnormal sound during rising and lowering, stop to use the lift.
- . Never use the lift to raise the vehicle whose weight is above 10000 lbs.

2. Simple Introduction on Main Parts of the Equipment

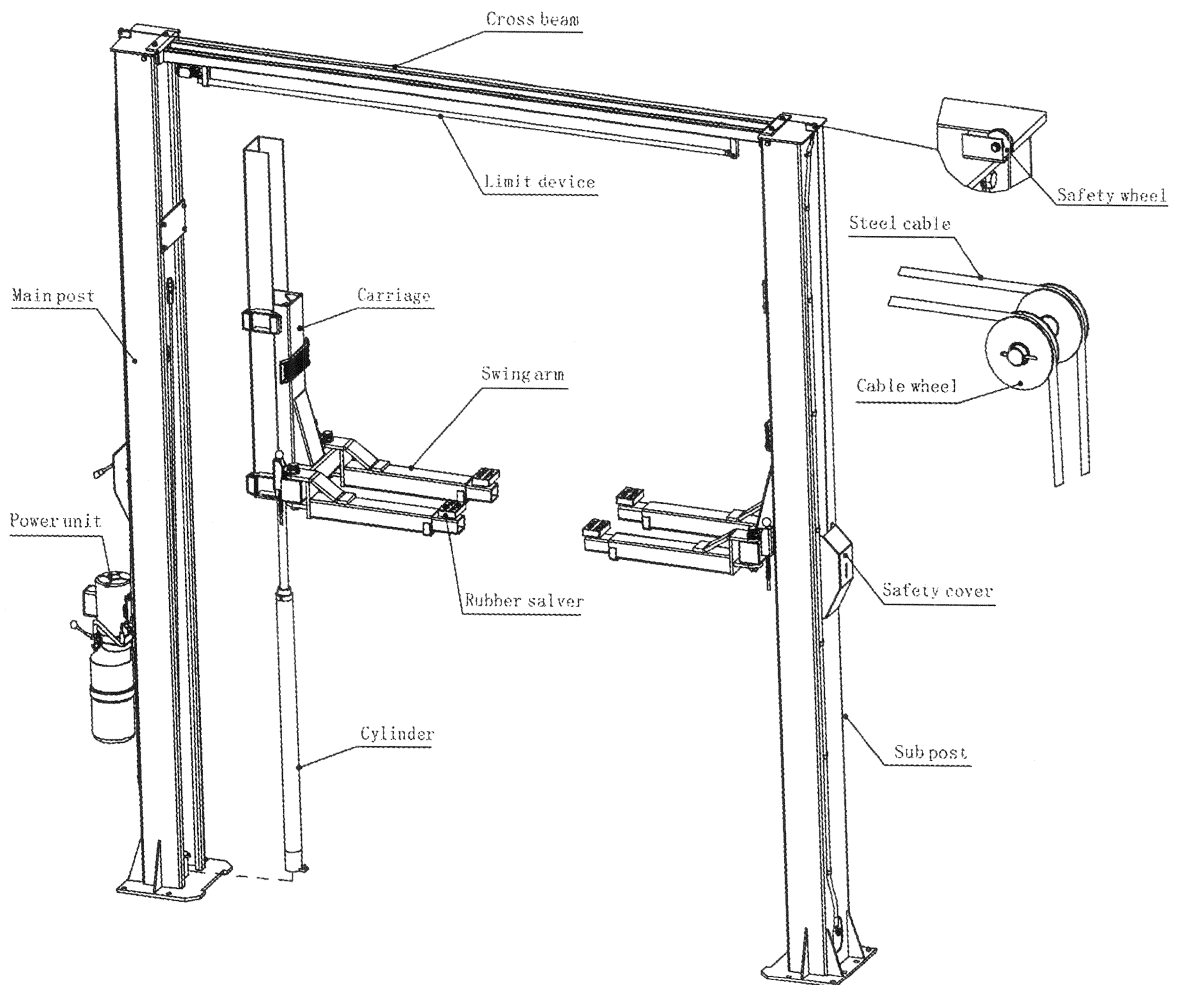

3. Basic Parameters of the Equipment

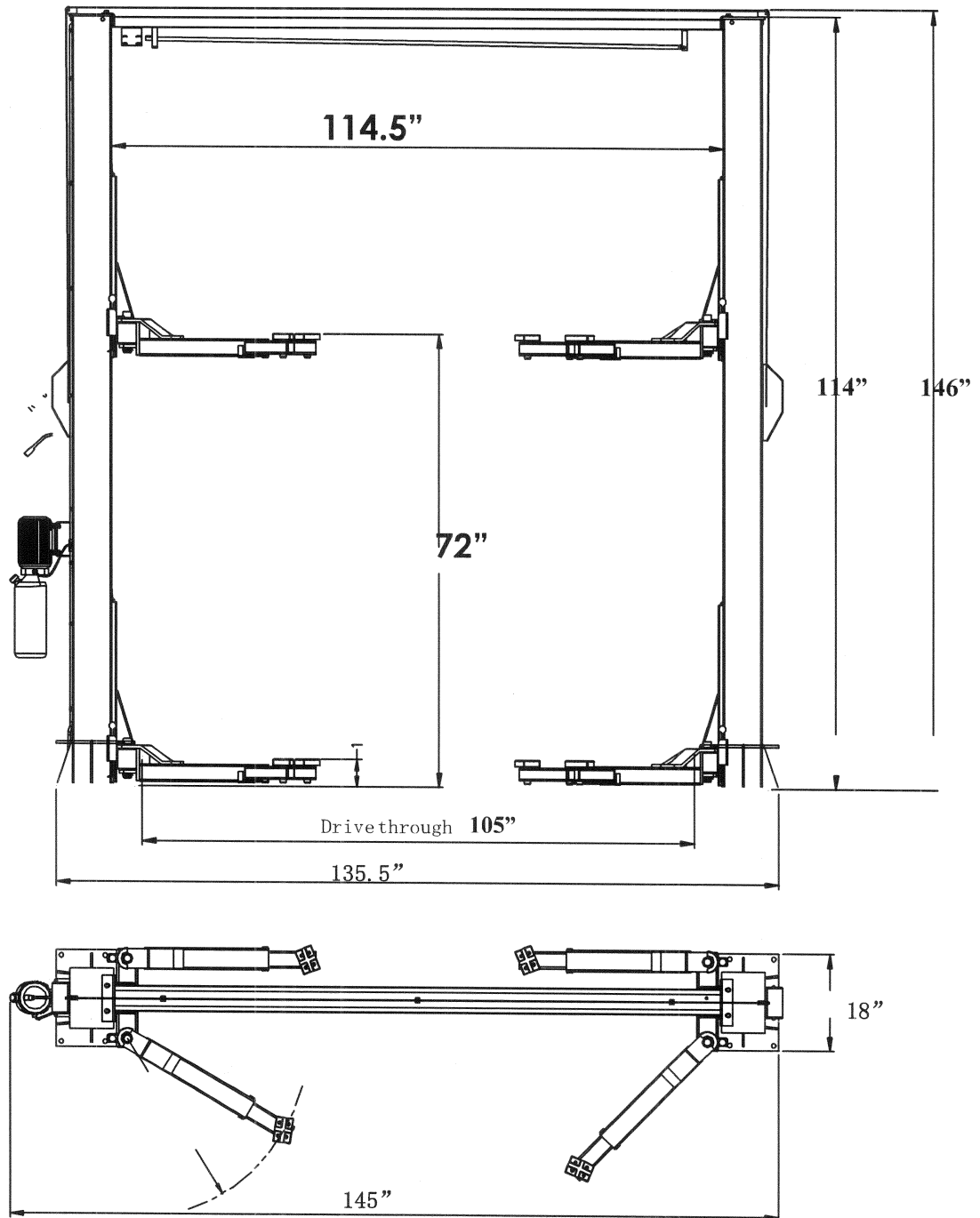

Step2. Installation of main and supplementary columns

Set up the two columns, mark with the marking pen according to the dimension of the foundation, and fix the two columns with expansion anchor bolt as the following shows. (See figure below)

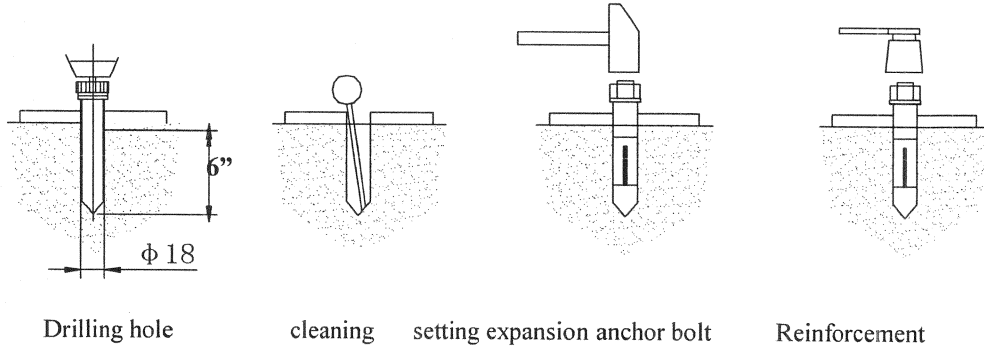

Attention:



Check to make sure that it is vertical between columns and ground, and the installation dimension should be as follows. (See figure below)

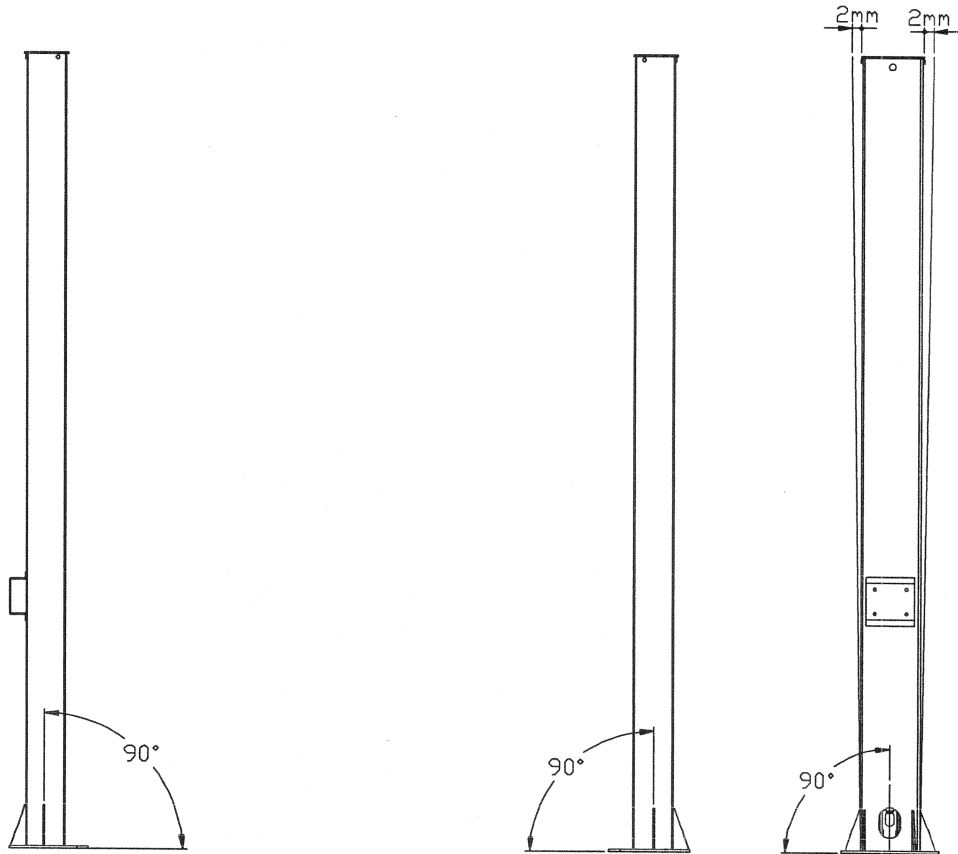

Two Post One Side Handle Release Hydraulic Lift

Step3. Fix the power unit to the main column.

Step4. Install the over beam.

Raise the carriage to the height about 36", then drop it to the safe state to make sure it will not fall again.

Step5. Installation of oil hose and chain

Please install oil pipeline and chain as the following picture shows.

Oil pipeline connecting picture

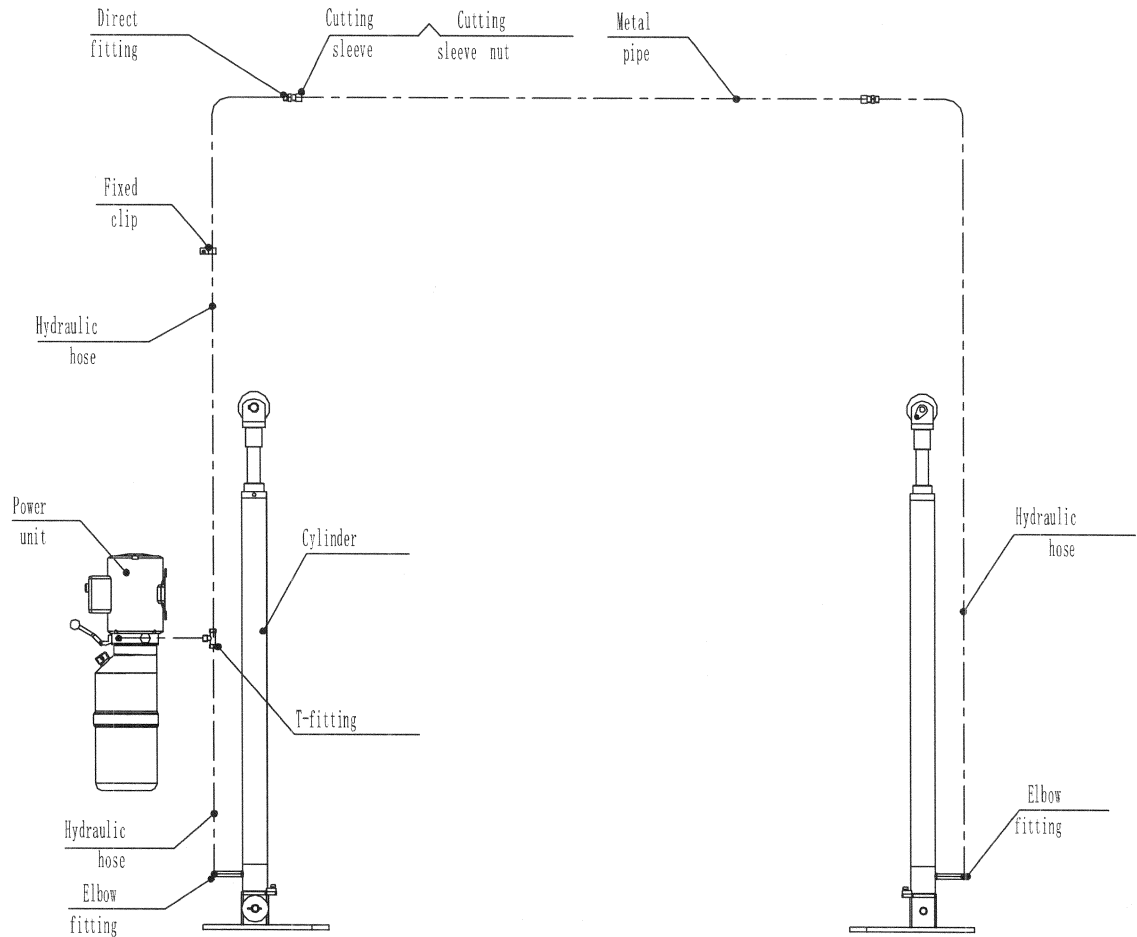

Chain Connecting Picture

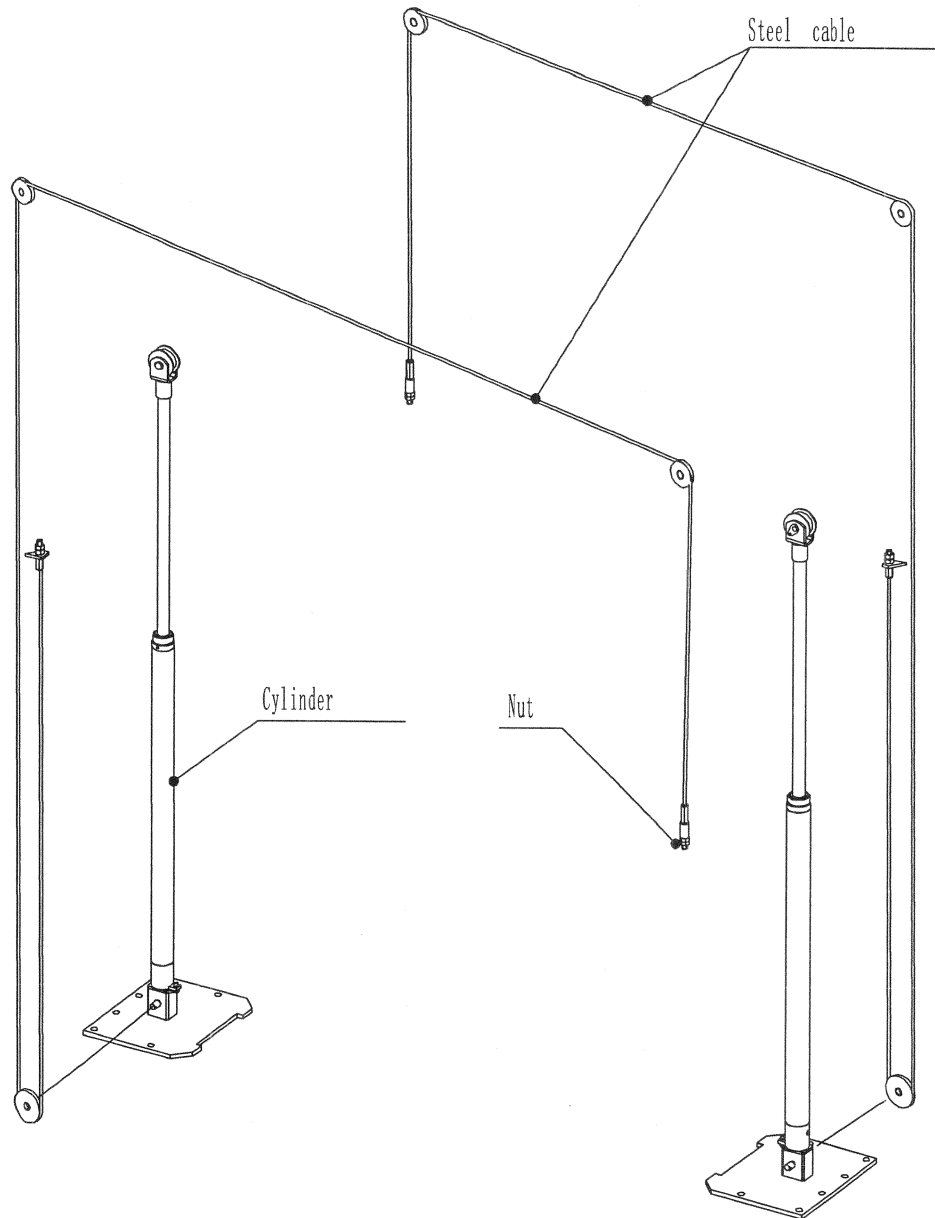

Step6. Installation of bracket arms

Install four arms on two columns respectively with short arms at the same side of the columns as the long arms are, and rock the arms to make sure they are installed properly.

Step7. Install the arm locking parts.

Step8. Fill hydraulic oil.

Step9. Connect the power.

Connect the power according to the pictures on the nameplate. It is required to set a power switch besides the lift, to cut off the power to maintain the equipment or cope with emergency.

Step10. Lubricate the slide rails inside the two columns.

Step11. Test the lift with empty load.

Check the tension in the chains and make sure the two columns are moving together.

Step12. Test the lift with heavy load.

Check whether the hydraulic system is working normally.



Don't install the lift if the foundation strength is not up to the standard.



Only trained electric technician can operate the electrical system.

5. The checking points before using the lift.

5.1 General checking points

Item	Possible problems	Method	Solution
1	Abnormal sounds when the lift rise or drop.	Seeing and listening	Add lubricating oil, clean and replace the parts.
2	Damage or deformation of the lift.	Seeing	Maintain and replace for the new parts
3	Deformation attrition of rubber pad and chain sheave	Seeing	
4	Abnormal sound of the oil pipeline system when the lift is rising and falling	Seeing and listening	
5	Foreign material inside the columns	Seeing	Clean, maintain, or replace for the new parts

5.2 Main checking points

Item	Checking content	Method	Solution
1	Check if there is any damage on chain.	Seeing	Replace for new parts.
2	Check if bolts are loose or not.	Seeing	Tighten the bolts and nuts.
3	Check if the chain sheave is normal or not.	Operating and seeing	Replace for new parts.
4	Check whether the chain sheave is working normally.	Operating and seeing	Add the lubrication, clean the chain sheave and replace for new parts.
5	Check if the bracket arm and its extension part are normal or not.	Seeing	Maintain and replace for new parts.
6	Check if the two collars are rising or dropping normally.	Operating	Clean the foreign material and add the lubrication.
7	Check if the magnet and safety hook are working normally.	Operating and seeing and listening	Change the magnet rod and replace for new parts.
8	Check if the lift stops automatically when it rise to its top level.	Operating	Maintain and replace for new parts.
9	Check when the power unit is working, if there is any abnormal sound.	Operating and listening	Maintain and replace for new parts.
10	Check if the cylinder, pipeline, and the seals are leaking oil.	Operating and seeing	Maintain and replace for new parts.

6. Operating Instruction

. Before driving the car to the lift, repeatedly raising and dropping arms to make sure that security locking system is normal. Check all connecting parts, especially the security parts. After checking all parts and being sure that there is no problem of the lift, people can use the lift.

. Before using the lift, adjust the height of the four rubber pads to make all supporting points in the same flat level, and separate the arms as open as possible so that it's easy for the vehicle to drive in, and it's better to use the short bracket arms to support the motor end.

. The center of lifting area should be the gravity center of the vehicle that needs maintaining. When the car is raised to 100 mm high, stop and swing the car a little to check whether lifting support is reasonable, and whether the lift is working normally, if everything is normal, go on to use the lift.

. When lift is rising, operator and other people should stand in the safety area. When the vehicle is raised to the required height, press the locking button to lock the lift, then the maintainer can start his work to repair the vehicle.

. Cut off the power when the maintainer is not in the working area to avoid any accident caused by the wrong operations by non-operators.

. Remain clearance under the bracket arms when the lift is dropping, or the lift will be damaged.

. Fill the oil tank of hydraulic power unit with approximately 3 gallons of new hydraulic oil.

. After pressing the down button the lift will rise a bit then drop.

. Cut off the power when repairing the vehicle and there is no operator or nobody using the lift.

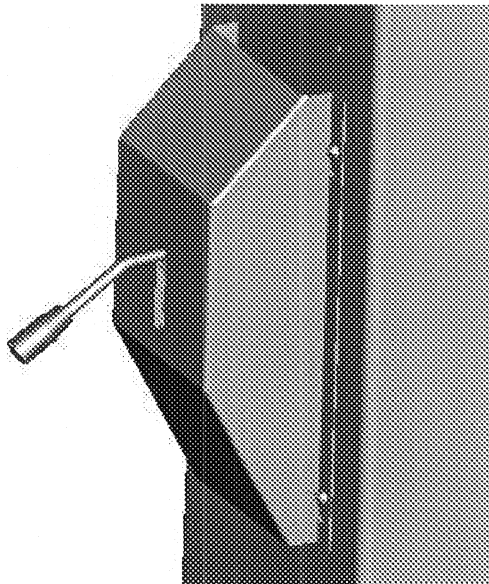

Lock Release Handle

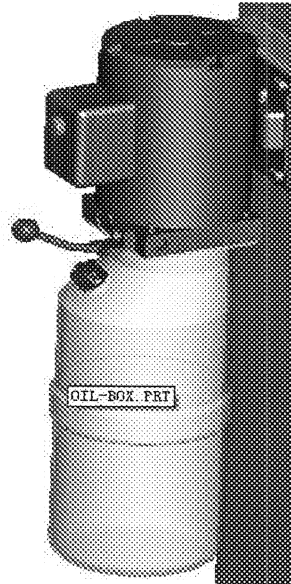

Down Handle

7. Maintenance and care of the equipment

7.1 Day care

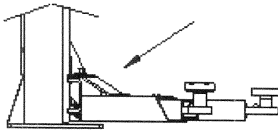
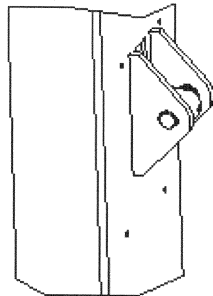
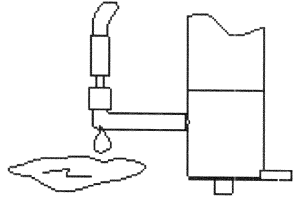
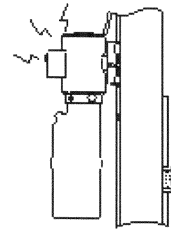
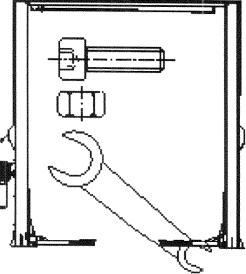
Item	Maintenance Contents	Solution	picture
1	Check if there are any damages on the rubber pad of four bracket arms.	Replace for new parts.	
2	Check if there is any problem on the bolts, nuts, and cotter pin of all spare parts.	Tighten, clean or replace for new parts.	
3	Check if the pivot chain sheave and chain are in their position.	Add lubrication or adjust again.	
4	Check if the sliding parts are clean, how is the elastic condition of torsional spring and is it safe enough of safety security system.	Add lubrication, adjust magnet roads or replace for new parts.	
5	Check the connection of oil pipeline to see whether it is leaking oil.	Find the leakage and tighten them with spanner and clean oil stains.	
6	Check if it is time to add or change hydraulic oil.	Add or change the oil.	

7.2 Month care

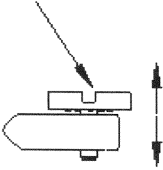
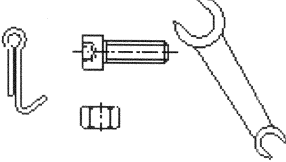
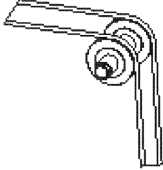
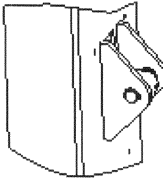
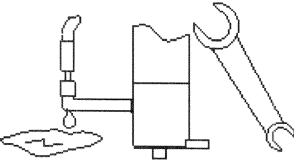
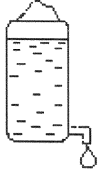
Item	Maintenance Contents	Solution	picture
1	Check if there are any damages on the rubber pad of four bracket arms.	Replace for new parts.	
2	Check if there is any problem on the bolts, nuts, and cotter pin of all spare parts.	Tighten, clean or replace for new parts.	
3	Check if the pivot chain sheave and chain are in their position.	Add lubrication or adjust again.	
4	Check if the sliding parts are clean, how is the elastic condition of torsional spring and is it safe enough of safety security system.	Add lubrication, adjust magnet roads or replace for new parts.	
5	Check the connection of oil pipeline to see whether it is leaking oil.	Find the leakage and tighten them with spanner and clean oil stains.	
6	Check if it is time to add or change hydraulic oil.	Add or change the oil.	
7	Check if there is any rusts on spare parts.	Remove the rust, add oil and repaint.	

8. Trouble Shooting

Malfunctions	Cause	Solution
Generator does not work.	The power source or power equipment is malfunctioning.	Check up the power fuse, the contact in the junction box of motor, miro switch, and the condition of up button, change the damaged part.
Generator roars and does not work.	<ul style="list-style-type: none"> a. The top of vane wheel is deformed. b. Capacitor is damaged. c. The voltage is too low. d. The equipment is used overloadedly. 	<ul style="list-style-type: none"> a. straightening b. replace for new parts c. check up by electric technicians
When the lift is rising, it creeps.	Air has entered the hydraulic system, and the oil box lack oil.	Rise repeatedly to remove the air, and add oil to oil box.
Two sliding collars don't rise tighter.	The adjusting chain is loose.	Adjust chains, twist the screw to tighten chains to make the two collars in the same flat level.
Noise is too loud when the lift is working.	The sliding and rotational part lack lubrication and or change the pin roll.	Add lubrication, change the pin roll.
The lift can't rise.	<ul style="list-style-type: none"> a. There is something wrong with the power unit. b. Spare parts of electric control box are damaged. c. Damage of limit switch d. Leakage of oil pipeline 	<ul style="list-style-type: none"> a. Maintenance or change for new parts. b. Maintain or change for new parts. c. Change for new parts. d. Clean, tighten and change for new parts.
When lift is rising the speed is slow and heavy.	<ul style="list-style-type: none"> a. There is not enough hydraulic oil. b. Leakage of oil pipeline c. Oil filter is stopped up. 	<ul style="list-style-type: none"> a. Add hydraulic oil b. Maintenance, tighten and change for new parts. c. Disassemble and clean.
The lift can't drop.	<ul style="list-style-type: none"> a. The security block is not open. b. Magnets are damaged heavily. 	<ul style="list-style-type: none"> a. Rise first then drop, or maintain. b. Change for new parts.

To customers

We try our best to provide the details of installation, operating and maintenance, to insure our customers use the lift safely. If you have any problem during installation and using, please feel free to contact us and we will reply you as soon as possible.